

NBC-10,0-94B/FS SCO - Network cable



1407442

<https://www.phoenixcontact.com/us/products/1407442>

Please be informed that the data shown in this PDF document is generated from our online catalog. Please find the complete data in the user documentation. Our general terms of use for downloads are valid.



Network cable, Ethernet CAT5 (1 Gbps), 8-position, shielded, free cable end, on Socket straight M12 SPEEDCON, coding: A / IP67, cable length: 10 m

Commercial data

Item number	1407442
Packing unit	1 pc
Minimum order quantity	1 pc
Sales key	BF04
Product key	BF1CMI
Catalog page	Page 401 (C-2-2019)
GTIN	4046356775632
Weight per piece (including packing)	500.6 g
Weight per piece (excluding packing)	477 g
Customs tariff number	85444210
Country of origin	PL

1407442

<https://www.phoenixcontact.com/us/products/1407442>

Technical data

Notes

General	Further products with variable cable type and variable cable length can be found in the accessories section
---------	---

Product properties

Product type	Data cable preassembled
Sensor type	Ethernet
Number of positions	8
Application	Standard
No. of cable outlets	1
Shielded	yes
Coding	A

Interfaces

Bus system	Ethernet
Signal type/category	Ethernet CAT5 (based on IEC 11801), 1 Gbps

Signaling

Status display	No
Status display present	No

Electrical properties

Nominal voltage U_N	48 V AC
	60 V DC
Nominal current I_N	2 A
Transmission medium	Copper
Transmission characteristics (category)	CAT5 (IEC 11801:2002)

Material specifications

Seal material	NBR
---------------	-----

Connector

Connection 1

Type	free cable end
------	----------------

Connection 2

Type	Socket straight M12 SPEEDCON / IP67
Number of positions	8
Locking type	SPEEDCON
Coding type	A (Standard)
Handle color	black
	CuZn (Contact)

NBC-10,0-94B/FS SCO - Network cable



1407442

<https://www.phoenixcontact.com/us/products/1407442>

Material	Ni/Au (Contact surface)
	TPU GF (Contact carriers)
	TPU, hardly inflammable, self-extinguishing (Grip)
	Zinc die-cast, nickel-plated (Screw connection)
Insertion/withdrawal cycles	≥ 100
Contact resistance	≤ 5 mΩ
Insulation resistance	≥ 100 MΩ
Tightening torque	0.4 Nm
Degree of protection	IP67
Ambient temperature (operation)	-25 °C ... 90 °C

Cable/line

Cable length	10 m
--------------	------

Ethernet flexible CAT5, 4-pair [94B]

Dimensional drawing	
Cable weight	47 kg/km
UL AWM Style	20963 (80°C/30 V)
Number of positions	8
Shielded	yes
Cable type	Ethernet flexible CAT5, 4-pair [94B]
Conductor structure	4x2xAWG26/7, SF/UTP
Signal runtime	5.3 ns/m
Conductor structure signal line	7x 0.16 mm
AWG signal line	26
Conductor cross section	4x 2x 0.14 mm ²
Wire diameter incl. insulation	0.96 mm
External cable diameter	6.4 mm ±0.2 mm
Outer sheath, material	PUR
External sheath, color	water blue RAL 5021
Conductor material	Bare Cu litz wires
Material wire insulation	Foamed PE
Single wire, color	white/blue-blue, white/orange-orange, white/green-green, white/brown-brown
Thickness, outer sheath	1.05 mm
Twisted pairs	2 cores to the pair
Overall twist	4 pairs for core

NBC-10,0-94B/FS SCO - Network cable



1407442

<https://www.phoenixcontact.com/us/products/1407442>

Optical shield covering	70 %
Insulation resistance	≥ 5 GΩ*km
Coupling resistance	≤ 100.00 mΩ/m (at 10 MHz)
Loop resistance	≤ 290.00 Ω/km
Wave impedance	100 Ω ±5 Ω (at 100 MHz)
Cable capacity	48 nF/km (at 1 kHz)
Nominal voltage, cable	≤ 100 V
Test voltage Core/Core	700 V (50 Hz, 1 min.)
Test voltage Core/Shield	700 V (50 Hz, 1 min.)
Minimum bending radius, fixed installation	4 x D
Minimum bending radius, flexible installation	8 x D
Smallest bending radius, fixed installation	26 mm
Smallest bending radius, movable installation	52 mm
Tensile strength	≤ 100 N
Near end crosstalk attenuation (NEXT)	71.3 dB (with 1 MHz)
	62.3 dB (at 4 MHz)
	56.3 dB (at 10 MHz)
	53.2 dB (at 16 MHz)
	51.8 dB (at 20 MHz)
	48.9 dB (at 31.25 MHz)
	44.4 dB (at 62.5 MHz)
Power-summated near end crosstalk attenuation (PSNEXT)	41.3 dB (at 100 MHz)
	62.3 dB (with 1 MHz)
	53.3 dB (at 4 MHz)
	47.3 dB (at 10 MHz)
	44.2 dB (at 16 MHz)
	42.8 dB (at 20 MHz)
	39.9 dB (at 31.25 MHz)
35.4 dB (at 62.5 MHz)	
Return attenuation (RL)	32.3 dB (at 100 MHz)
	23 dB (at 4 MHz)
	24.1 dB (at 8 MHz)
	25 dB (at 10 MHz)
	25 dB (at 16 MHz)
	25 dB (at 20 MHz)
	23.6 dB (at 31.25 MHz)
	21.5 dB (at 62.5 MHz)
20.1 dB (at 100 MHz)	
Shield attenuation	3.2 dB (with 1 MHz)
	6 dB (at 4 MHz)
	9.5 dB (at 10 MHz)
	12.1 dB (at 16 MHz)
	13.6 dB (at 20 MHz)
	17.1 dB (at 31.25 MHz)

NBC-10,0-94B/FS SCO - Network cable



1407442

<https://www.phoenixcontact.com/us/products/1407442>

	24.8 dB (at 62.5 MHz)
	32 dB (at 100 MHz)
Halogen-free	according to IEC 60754-1
Flame resistance	according to IEC 60332-1-2
Resistance to oil	in accordance with EN 60811-2-1
Ambient temperature (operation)	-40 °C ... 80 °C (cable, fixed installation)
	-20 °C ... 80 °C (Cable, flexible installation)
Ambient temperature (installation)	-20 °C ... 80 °C

Environmental and real-life conditions

Ambient conditions

Degree of protection	IP65
	IP67
	IP65/IP67
Ambient temperature (operation)	-25 °C ... 85 °C (M12 connector)

Standards and regulations

M12

Standard designation	M12 connector
Standards/specifications	IEC 61076-2-101

Drawings

Circuit diagram

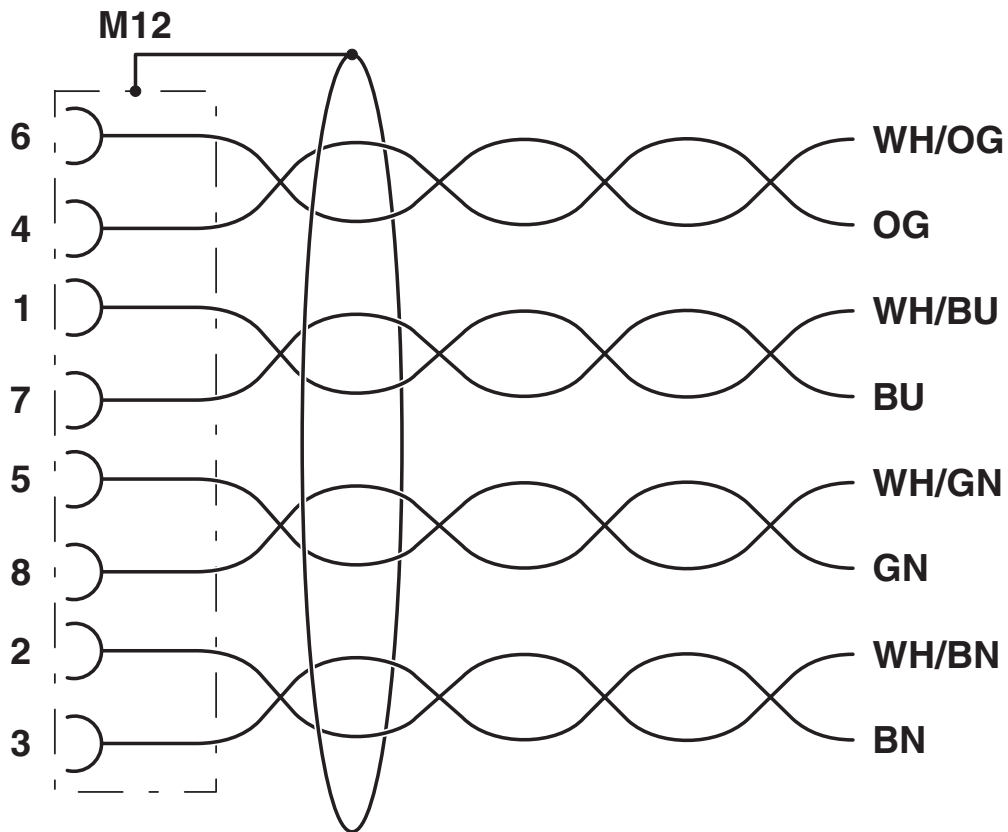

Dimensional drawing

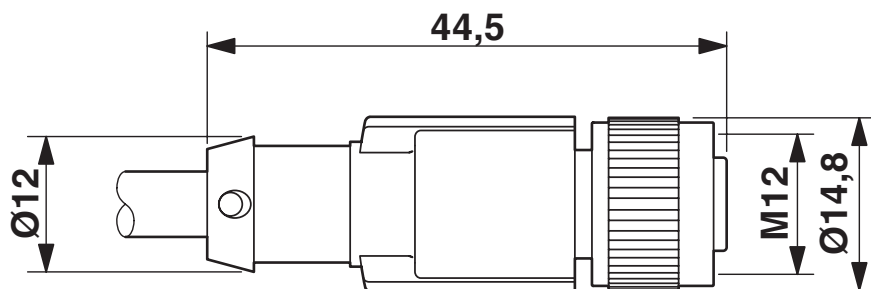

M12 x 1 socket, straight, shielded

NBC-10,0-94B/FS SCO - Network cable

1407442

<https://www.phoenixcontact.com/us/products/1407442>



Schematic diagram

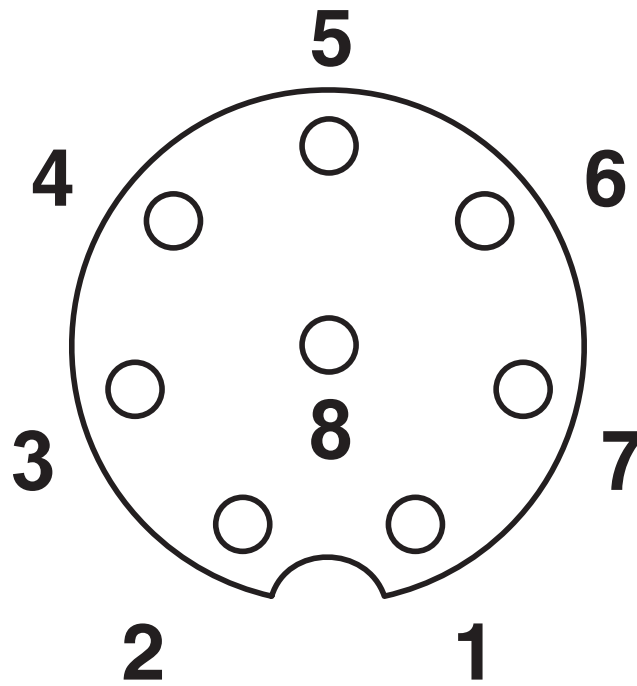

Pin assignment M12 socket, 8-pos., A-coded, view female side

NBC-10,0-94B/FS SCO - Network cable





1407442

<https://www.phoenixcontact.com/us/products/1407442>

Approvals

To download certificates, visit the product detail page: <https://www.phoenixcontact.com/us/products/1407442>

 cUL Recognized Approval ID: FILE E 335024				
	Nominal voltage U_N	Nominal current I_N	Cross section AWG	Cross section mm^2
	30 V	1.5 A	-	-

 UL Recognized Approval ID: FILE E 335024				
	Nominal voltage U_N	Nominal current I_N	Cross section AWG	Cross section mm^2
	30 V	1.5 A	-	-

 EAC-RoHS Approval ID: RU D-DE.HB35.B.00387	
---	--

cULus Recognized	
-------------------------	--

NBC-10,0-94B/FS SCO - Network cable



1407442

<https://www.phoenixcontact.com/us/products/1407442>

Classifications

ECLASS

ECLASS-11.0	27060307
ECLASS-12.0	27060307
ECLASS-13.0	27060307

ETIM

ETIM 9.0	EC001855
----------	----------

UNSPSC

UNSPSC 21.0	26121600
-------------	----------

NBC-10,0-94B/FS SCO - Network cable



1407442

<https://www.phoenixcontact.com/us/products/1407442>

Environmental product compliance

China RoHS	Environmentally friendly use period: unlimited = EFUP-e
	No hazardous substances above threshold values

NBC-10,0-94B/FS SCO - Network cable

1407442

<https://www.phoenixcontact.com/us/products/1407442>



Accessories

NBC-MS SCO-IE/.../... - Network cable

1408682

<https://www.phoenixcontact.com/us/products/1408682>

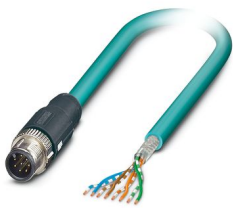

Network cable, Ethernet CAT5 (1 Gbps), 8-position, Variable cable type, shielded, Plug straight M12 SPEEDCON, coding: A / IP67, on free cable end, cable length: Free input (0.2 ... 40.0 m)

NBC-MR SCO-IE/.../... - Network cable

1408675

<https://www.phoenixcontact.com/us/products/1408675>



Network cable, Ethernet CAT5 (1 Gbps), 8-position, Variable cable type, shielded, Plug angled M12 SPEEDCON, coding: A / IP67, on free cable end, cable length: Free input (0.2 ... 40.0 m)

NBC-10,0-94B/FS SCO - Network cable

1407442

<https://www.phoenixcontact.com/us/products/1407442>



NBC-FS SCO-IE/.../... - Network cable

1408665

<https://www.phoenixcontact.com/us/products/1408665>



Network cable, Ethernet CAT5 (1 Gbps), 8-position, Variable cable type, shielded, free cable end, on Socket straight M12 SPEEDCON, coding: A / IP67, cable length: Free input (0.2 ... 40.0 m)

NBC-FR SCO-IE/.../... - Network cable

1408657

<https://www.phoenixcontact.com/us/products/1408657>



Network cable, Ethernet CAT5 (1 Gbps), 8-position, Variable cable type, shielded, free cable end, on Socket angled M12 SPEEDCON, coding: A / IP67, cable length: Free input (0.2 ... 40.0 m)

NBC-10,0-94B/FS SCO - Network cable

1407442

<https://www.phoenixcontact.com/us/products/1407442>



PROT-M12 MS-PA-CHAIN - Screw plug

1430899

<https://www.phoenixcontact.com/us/products/1430899>

M12 sealing cap with fixing band, for sensor cables, for free M12 sockets



SAC-M12-EXCLIP-F - Locking clip

1558991

<https://www.phoenixcontact.com/us/products/1558991>

Locking clip for the socket side of sensor/actuator cables with M12 connector and M12 connectors for assembly, for knurl diameter: 15 mm or for Allen key with a wrench size of 14 mm, prevents the disconnection of plug-in connections without tools



NBC-10,0-94B/FS SCO - Network cable

1407442

<https://www.phoenixcontact.com/us/products/1407442>



WP-CTA POM 13,0 BK - Protective hose adapter

1422884

<https://www.phoenixcontact.com/us/products/1422884>



Protective hose adapter, for corrugated hoses with a nominal size of 13 (10 x 13), corrugated in parallel

WP-PA HF 13,0 BK - Protective hose

3240681

<https://www.phoenixcontact.com/us/products/3240681>



Protective hose, material: PA 6, UV-resistant: yes, flexible, degree of protection: IP68, color: black, flammability rating in acc. with UL 94: V0, inner diameter: 10 mm, Total length: 50 m

NBC-10,0-94B/FS SCO - Network cable

1407442

<https://www.phoenixcontact.com/us/products/1407442>



WP-PA HF-HB 13,0 BK - Protective hose

3240839

<https://www.phoenixcontact.com/us/products/3240839>



Protective hose, material: PA 6, UV-resistant: yes, flexible, degree of protection: IP68, color: black, flammability rating in acc. with UL 94: HB, inner diameter: 10 mm, Total length: 50 m

SACC-M12MS-8QO SH ETH - Data connector

1421679

<https://www.phoenixcontact.com/us/products/1421679>



Data connector, Ethernet CAT5 (1 Gbps), 8-position, halogen-free, shielded, Plug straight M12, coding: A, Insulation displacement connection, knurl material: Zinc die-cast, nickel-plated, external cable diameter 5 mm ... 9.7 mm

NBC-10,0-94B/FS SCO - Network cable

1407442

<https://www.phoenixcontact.com/us/products/1407442>



SACC-M12MR-8Q SH - Data connector

1553653

<https://www.phoenixcontact.com/us/products/1553653>



Data connector, Ethernet CAT5 (1 Gbps), 8-position, shielded, Plug angled M12, coding: A, Insulation displacement connection, knurl material: Brass, nickel-plated, external cable diameter 4 mm ... 8 mm

SACC-M12FS-8QO SH ETH - Data connector

1421680

<https://www.phoenixcontact.com/us/products/1421680>



Data connector, Ethernet CAT5 (1 Gbps), 8-position, halogen-free, shielded, Socket straight M12, coding: A, Insulation displacement connection, knurl material: Zinc die-cast, nickel-plated, external cable diameter 5 mm ... 9.7 mm

NBC-10,0-94B/FS SCO - Network cable



1407442

<https://www.phoenixcontact.com/us/products/1407442>

SACC-M12FR-8Q SH - Data connector

1553666

<https://www.phoenixcontact.com/us/products/1553666>



Data connector, Ethernet CAT5 (1 Gbps), 8-position, shielded, Socket angled M12, coding: A, Insulation displacement connection, knurl material: Brass, nickel-plated, external cable diameter 4 mm ... 8 mm

VS-08-RJ45-5-Q/IP20 - RJ45 connector

1656725

<https://www.phoenixcontact.com/us/products/1656725>



RJ45 connector, design: RJ45, degree of protection: IP20, number of positions: 8, 1 Gbps, CAT5, material: Plastic, connection method: Insulation displacement connection, connection cross section: AWG 26- 23, cable outlet: straight, color: traffic grey A RAL 7042, Ethernet

NBC-10,0-94B/FS SCO - Network cable

1407442

<https://www.phoenixcontact.com/us/products/1407442>

VS-08-RJ45-5-Q/IP20 BK - RJ45 connector

1658008

<https://www.phoenixcontact.com/us/products/1658008>



RJ45 connector, design: RJ45, degree of protection: IP20, number of positions: 8, 1 Gbps, CAT5, material: Plastic, connection method: Insulation displacement connection, connection cross section: AWG 26- 23, cable outlet: straight, color: black, Ethernet

CUC-IND-C1ZNI-S/R4IE8 - RJ45 connector

1421607

<https://www.phoenixcontact.com/us/products/1421607>



RJ45 connector, design: RJ45, degree of protection: IP20, number of positions: 8, 1 Gbps, CAT5, material: Metal, connection method: Insulation displacement connection, connection cross section: AWG 26- 24, cable outlet: straight, color: green, Ethernet

NBC-10,0-94B/FS SCO - Network cable



1407442

<https://www.phoenixcontact.com/us/products/1407442>

CUC-IND-C1ZNI-T/R4IE8 - RJ45 connector

1421877

<https://www.phoenixcontact.com/us/products/1421877>



RJ45 connector, design: RJ45, degree of protection: IP20, number of positions: 8, 1 Gbps, CAT5, material: Metal, connection method: Insulation displacement connection, connection cross section: AWG 26- 24, cable outlet: angled, Ethernet

CUC-IND-C1ZNI-B/R4IE8 - RJ45 connector

1421876

<https://www.phoenixcontact.com/us/products/1421876>



RJ45 connector, design: RJ45, degree of protection: IP20, number of positions: 8, 1 Gbps, CAT5, material: Metal, connection method: Insulation displacement connection, connection cross section: AWG 26- 24, cable outlet: angled, Ethernet

NBC-10,0-94B/FS SCO - Network cable

1407442

<https://www.phoenixcontact.com/us/products/1407442>

CUC-V06-C1PGY-S/R4CE8:1 - RJ45 connector

1414383

<https://www.phoenixcontact.com/us/products/1414383>



RJ45 connector, design: RJ45, degree of protection: IP67, number of positions: 8, 1 Gbps, CAT6, material: Plastic, connection method: Crimp connection, connection cross section: AWG 27- 24, cable outlet: straight, color: gray, Ethernet/PROFINET

CUC-V06-C1PBK-S/R4CE8:1 - RJ45 connector

1414408

<https://www.phoenixcontact.com/us/products/1414408>



RJ45 connector, design: RJ45, degree of protection: IP67, number of positions: 8, 1 Gbps, CAT6, material: Plastic, connection method: Crimp connection, connection cross section: AWG 24- 27, cable outlet: straight, color: black, Ethernet/PROFINET

NBC-10,0-94B/FS SCO - Network cable



1407442

<https://www.phoenixcontact.com/us/products/1407442>

CUC-V14-C1ZNI-S/R4E8 - RJ45 connector

1422661

<https://www.phoenixcontact.com/us/products/1422661>



RJ45 connector, degree of protection: IP65/IP67, number of positions: 8, 1 Gbps, CAT5, material: Metal, connection method: IDC fast connection, connection cross section: AWG 26- 24, cable outlet: straight, Ethernet

CUC-V14-C1ZNI-T/R4E8 - RJ45 connector

1422663

<https://www.phoenixcontact.com/us/products/1422663>



RJ45 connector, degree of protection: IP65/IP67, number of positions: 8, 1 Gbps, CAT5, material: Metal, connection method: IDC fast connection, connection cross section: AWG 26- 24, cable outlet: angled, Ethernet

NBC-10,0-94B/FS SCO - Network cable



1407442

<https://www.phoenixcontact.com/us/products/1407442>

CUC-V14-C1ZNI-B/R4E8 - RJ45 connector

1422662

<https://www.phoenixcontact.com/us/products/1422662>



RJ45 connector, degree of protection: IP65/IP67, number of positions: 8, 1 Gbps, CAT5, material: Metal, connection method: IDC fast connection, connection cross section: AWG 26- 24, cable outlet: angled, Ethernet

VS-PPC-C1-RJ45-POBK-PG9-8Q5 - RJ45 connector

1657834

<https://www.phoenixcontact.com/us/products/1657834>



RJ45 connector, degree of protection: IP65/IP67, number of positions: 8, 1 Gbps, CAT5 (IEC 11801:2002), material: Plastic, connection method: IDC fast connection, connection cross section: AWG 26- 22, cable outlet: straight, color: black, Ethernet

NBC-10,0-94B/FS SCO - Network cable

1407442

<https://www.phoenixcontact.com/us/products/1407442>

TSD 04 SAC - Torque screwdriver

1208429

<https://www.phoenixcontact.com/us/products/1208429>



Torque screwdriver, with preset torque of 0.4 Nm and 4 mm hexagonal drive for M12 connectors

TSD-M 1,2NM - Torque screwdriver

1212224

<https://www.phoenixcontact.com/us/products/1212224>



Torque screw driver, accuracy as per EN ISO 6789 standard, adjustable from 0.3 - 1.2 Nm

NBC-10,0-94B/FS SCO - Network cable



1407442

<https://www.phoenixcontact.com/us/products/1407442>

TSD-M SAC-BIT ADAPTER - Adapter insert

1212600

<https://www.phoenixcontact.com/us/products/1212600>



Adapter bit for TSD-M...torque tools, E6.3-1/4" drive with 4 mm hexagon to accommodate SAC bits

SAC BIT M12-D15 - Tool

1208432

<https://www.phoenixcontact.com/us/products/1208432>



Nut for assembling sensor/actuator cables with M12 connector and M12 connectors for assembly, with a knurl diameter of 15 mm, for 4 mm hexagonal drive

NBC-10,0-94B/FS SCO - Network cable

1407442

<https://www.phoenixcontact.com/us/products/1407442>

CUTFOX 12 - Cable-cutting tool

1212128

<https://www.phoenixcontact.com/us/products/1212128>



Cable cutter, for copper and aluminum up to 12 mm diameter (up to 35 mm²)

CUTFOX-S VDE - Diagonal cutter

1212207

<https://www.phoenixcontact.com/us/products/1212207>



Diagonal cutter for hard (piano wire) and soft wires, VDE 1000 V AC/1500 V DC tested

NBC-10,0-94B/FS SCO - Network cable

1407442

<https://www.phoenixcontact.com/us/products/1407442>



VS-CABLE-STRIP-VARIO - Stripping tool

1657407

<https://www.phoenixcontact.com/us/products/1657407>

Stripping tool, for the multi-level stripping of shielded cables



MICROFOX-SP-1 - Diagonal cutter

1212487

<https://www.phoenixcontact.com/us/products/1212487>

Electronic diagonal cutter, tapered head, without chamfer, with opening spring, non-reflective phosphate-treated surface, punched version



NBC-10,0-94B/FS SCO - Network cable



1407442

<https://www.phoenixcontact.com/us/products/1407442>

WIREFOX 4 - Stripping tool

1212156

<https://www.phoenixcontact.com/us/products/1212156>



Stripping tool, for cables and conductors (especially for rubber and silicone insulations) from 0.1 - 4 mm², self-adjusting, stripping length of up to 18 mm, cutting capacity of up to 10 mm² stranded/1.5 mm² solid, replaceable stripping blade

WIREFOX-E 4 - Stripping tool

1212704

<https://www.phoenixcontact.com/us/products/1212704>



Stripping tool, for cables and conductors (especially for rubber and silicone insulations) from 0.1 - 4 mm², self-adjusting, stripping length of up to 18 mm, cutting capacity of up to 10 mm² stranded/1.5 mm² solid, replaceable stripping blade

NBC-10,0-94B/FS SCO - Network cable



1407442

<https://www.phoenixcontact.com/us/products/1407442>

WIREFOX 10 - Stripping tool

1212150

<https://www.phoenixcontact.com/us/products/1212150>



Stripping tool, for cables and conductors from 0.02 - 10 mm², self-adjusting, stripping length of up to 18 mm, cutting capacity of up to 10 mm² stranded/1.5 mm² solid, replaceable stripping blade

Phoenix Contact 2024 © - all rights reserved

<https://www.phoenixcontact.com>

Phoenix Contact USA
586 Fulling Mill Road
Middletown, PA 17057, United States
(+717) 944-1300
info@phoenixcon.com